

DATA SHEET



DIGIMESA

FF John Guest 8mm (5/16")
sm 3 Pin Arnite
Part number: 981-5550

General Description

The FFJG 8mm (5/16") Flowmeter is a general-purpose precision device. It measures with constant precision and guarantees maximum accuracy in the measurement of fluid volumes. Its integrated electronic pulse emitter gives an additional guarantee for a practically unlimited useful life. This flowmeter is employed with great success in beer and premix dispensing systems. In addition to this, it can measure spirits or chemi-

cally-aggressive products and therefore finds much use in the most varied of industrial sectors just as accurately.

Special features: By means of its special jewelled bearing, its fitting position can be freely selected. Inlet and outlet are freely selectable. When frothing formation is detected, the built in electronic system interrupts the pulse output. Hose diameters from 8.0mm (5/16") can be directly connected.

Approvals / Standards

EN 50081-1:92, EN 50082-1:97,
EN 61000-3-2:00, EN 61000-3-3:95,
IEC 61000-6-3:96, IEC 61000-6-1:96,
IEC 61000-3-2-00, IEC 61000-3-3:94 + A1:01



Material:

Housing:	PBT 35%GF (Arnite)
Bearing pin:	Inox 1.4404, Ruby
O-ring:	MVQ (Silikon)
Turbine:	PVDF
Magnets:	Ceramic Sr Fe O (not in contact with the medium)
Probes:	Stainless steel 1.4404 with food quality PTFE coating

Technical data:

Flow rate:	0.34 - 11.5 l/min
Measuring accuracy:	+/- 2.0%
Repetition:	< +/- 0.25%
Temperature range:	-10°C to +65°C 14°F to 149°F
Pressure range:	5.5 bar at 20°C 79 psi /68°F
Mounting position:	freely selectable
Nozzle size:	Ø 5.0mm

Electrical connection ratings:

Power supply:	10-16 VDC
Consumption:	5 mA to max. 13 mA
Signal connection:	Open collector NPN
Signal voltage:	0 V GND
Signal load:	max. 20 mA
Leakage current:	max. 10 µA
Connections:	3-pin AMP 2.8 x 0.8 mm
Signal:	Square-wave output
Duty Cycle:	50% / ± 5%

Dimensions in mm:

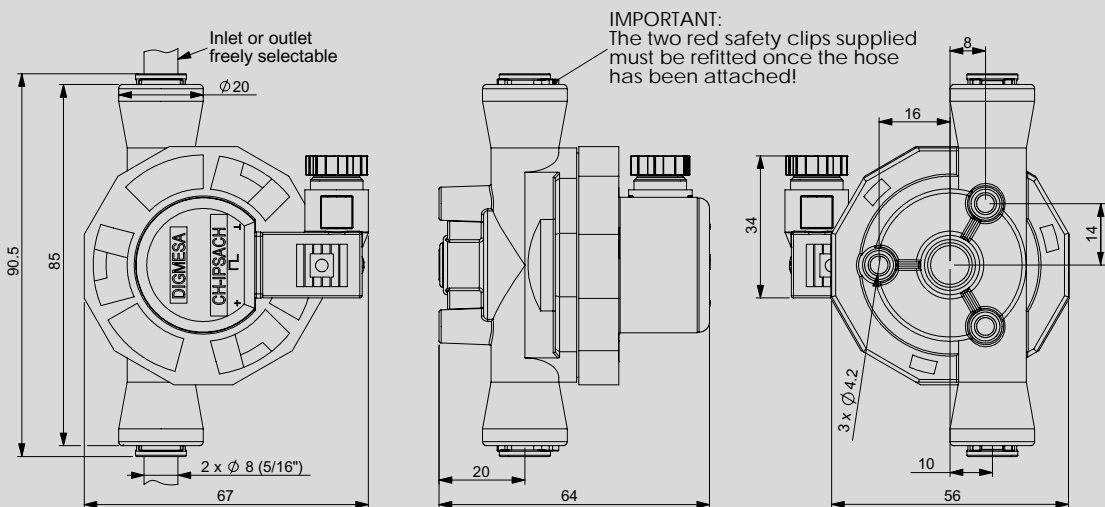

Included in the delivery:

3-pin solenoid socket
Item number: 941-0002/3



We reserve the right to make modifications in the interests of technical progress.

RESISTANCE

Special regulations which must be complied with by the flowmeter manufacturer apply to each country, e.g. CE, NSF, FDA and SK. The various media flowing through the flowmeter differ from application to application. You are advised to enquire with the medium manufacturer as to whether the entire installation and the flowmeter are resistant to the medium itself (see Material)!

ELECTRONIC

DIGMESA electronic circuitry is always designed for operation with DIGMESA flowmeters. Please note the following if connecting to other electronic circuitry:

- The flowmeter does not supply an output voltage but switches the signal terminal to 0 V ground (actuated) or leaves it open (non-actuated)
- There must be a pull-up resistor between power supply + and signal depending on electronic circuitry!

Version 01 FFJG 8mm (5/16") sm 981-5550 GB Page 2-7

Working Pressure and Temperature Range

Super Speedfit fittings are suitable for the following

Temp.	Pressure	
	5/32" - 5/16" 4mm - 6mm	3/8" - 1/2" 10mm - 22mm
Air	Temperature and Pressure range: as shown on page 2 under Technical data	
- 20°C		
Potable Liquids and Air		
+1°C		
+23°C		
+65°C		

Also suitable for vacuum

Depending on the tube used, under certain conditions fittings may be used at higher pressures and temperatures. Please refer to our Customer Services Department for guidance. Note 1 Bar = 14.5 PSIG.

Tube Types

Plastic Tube - Polyethylene, nylon and polyurethane conforming to the tolerances shown below. For soft tubing or thin wall tube we recommend the use of tube inserts.

Braided Tube - Use of Tube to Hose Stems listed on pages 5 and 12 is essential when using tube. Use of clamps to retain braided tube on barbs is recommended.

Metal Tube (soft) - Brass, copper or mild steel conforming to the tolerances below.

Metal Tube (hard) - We do not recommend **Super Speedfit** fittings for hard metal tubes.

For stainless steel and other polished metal tubes we recommend the use of **Superseal** fittings. These are shown on page 9 of this brochure.

It is essential that outside diameters be free from score marks and that the tube be deburred before inserting the fitting.

Tube Tolerances

Super Speedfit fittings are offered for tubes with outside diameters to the following tolerances.

Size (inches)	5/32 - 3/16	1/4 - 1/2
Tolerance (inches)	+0.001 / -0.003	+0.001 / -0.004
Size (mm)	4mm - 5mm	6mm - 22mm
Tolerance (mm)	+0.05 / -0.07	+0.05 / -0.10

Phone: (49)-521 / 9 72 56-0
 Fax: (49)-521 / 9 72 56-80
 Internet: <http://www.johnguest.com>
<http://www.speedfit.co.uk>

We reserve the right to make modifications in the interests of technical progress.

Installation and System Testing

Fittings and tube should be kept clean and undamaged before use.

All tube and fittings installations must be pressure tested after installation to ensure system integrity before handing over to the final user. See also "How to make a connection".

Chemicals

For use with chemicals or other potentially aggressive liquids, please refer to our Customer Services Department.

Super Speedfit fittings are not recommended for use with explosive gases, petroleum spirits, and other fuels or for central heating systems.

Collet Covers

Are available as additional security against removal of the tube or to provide a simple means of colour coding. The cover is offered in a range of six colours. Please see pages 6 and 12 of this brochure.

Food Quality

All the fittings in the brochure are produced in Food and Drug Administration (FDA) approved materials and are therefore recommended for food quality applications.



Maximum Torque Values for Plastic Threads BSP, BSPT & NPT.

	Threads		
	1/8 - 1/4	3/8 - 1/2	3/4
Max. Torque	1.5Nm	3.0Nm	4.0Nm

- It is recommended that all installations are checked prior to use to determine that a seal has been made.
- The maximum torque figures quoted for use with Speedfit fittings are dependent on the mating thread conforming to the relevant British or International thread standard.

Cleaners and Sanitising of Acetal Fittings

Our advice to customers is to use cleaners and sanitising agents that are above pH4 and low in hypochlorite level. Acetal fittings and parts that are cleaned and/or sanitised should be rinsed immediately with copious amounts of clean tap water to remove all traces of the cleaners. Details of which products are made from acetal are shown in our catalogues but generally John Guest products incorporating acetal are designated by the part number prefix PI, PM, CI, CM and RM. Polypropylene fittings offer greater resistance to aggressive chemicals than acetal fittings. Polypropylene does not have the same mechanical properties as acetal and John Guest polypropylene fittings are generally designated by the part number prefix PP. Our material suppliers recommend ECOLAB Oasis 133 as a suitable external cleaner for acetal products manufactured by John Guest.

Warranty

Whilst we give a warranty against defects in manufacture or materials, it is the responsibility of the specifier to ensure that fittings and related products are suitable for their application. The installation must be carried out correctly in accordance with our recommendations, complying with recognised codes of practice and relevant national

Upper part of FF frothing probe sm 3 or 4 pin

UPPER PART 3 PIN

The frothing probes are in contact with the medium. They recognize whether fluid or froth is present. This information is passed on to the electronic system integrated into the upper part.

When frothing is detected:

- The built-in electronic system interrupts the pulse output
- No further impulses are passed on.

UPPER PART 4 PIN

The frothing probes are in contact with the medium. They recognize whether fluid or froth is present. This information is passed on to the electronic system integrated into the upper part.

When frothing is detected:

- Pulses continue to be passed on.
- The built-in electronic system releases a signal via 4th pin, which needs to be evaluated.

e.g. Block puls input
Switch over keg
Acoustic / optical display

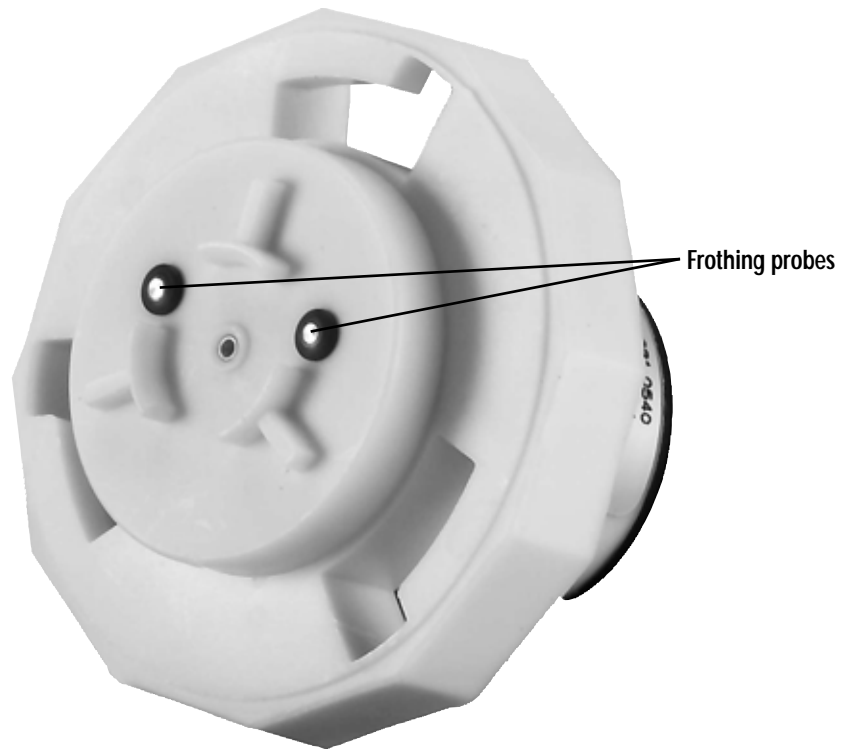

DIGITAL

Interface Connection: Examples sm 3 Pin

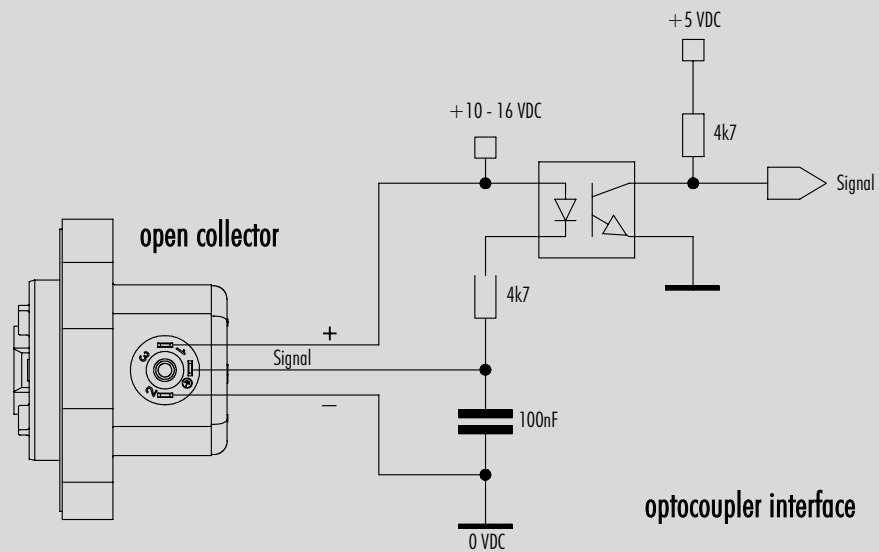
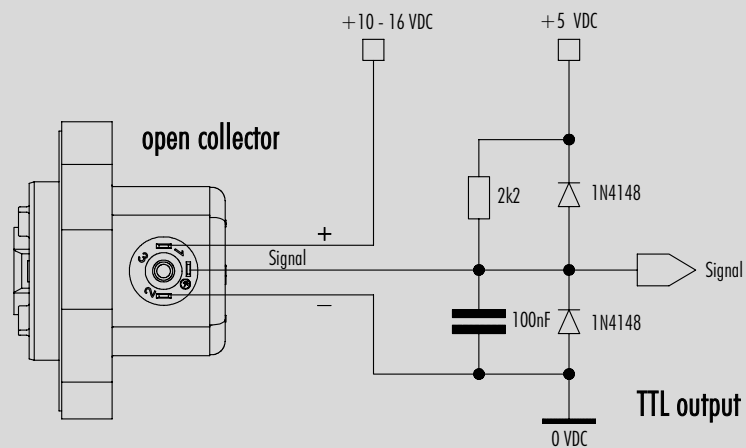
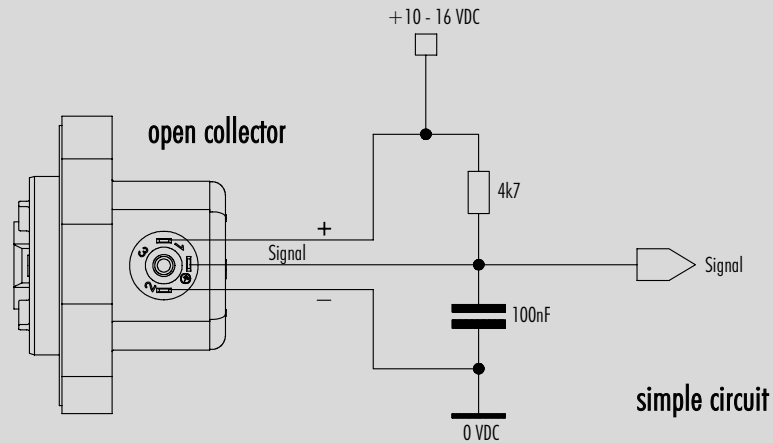

Measurement Curve FF Ø5.00 mm

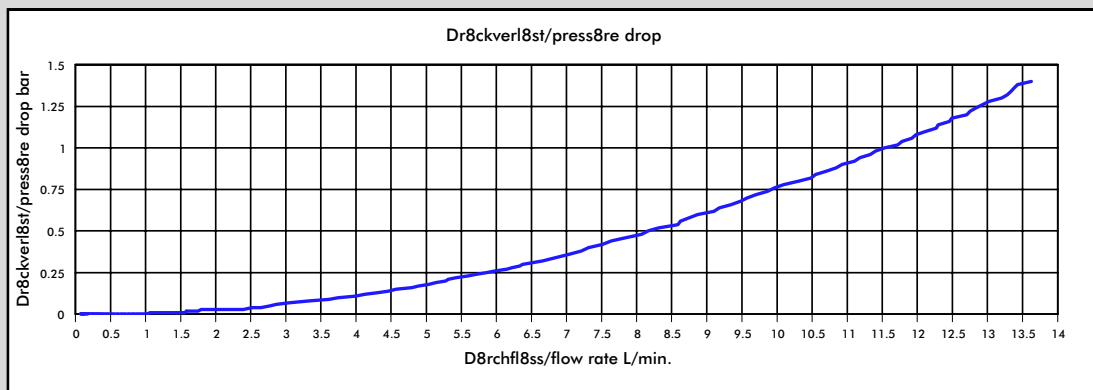
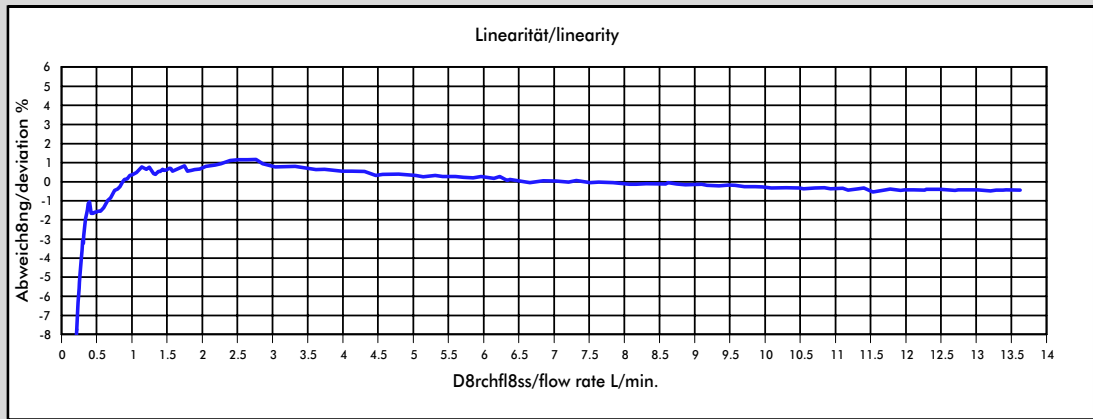

Medium: Water / max. Pressure: 3.3 bar

Nozzle size	Pulses/litre	g/pulse	min. flow rate in litres/min at Linear start	max. flow rate in litres/min	Pressure loss
Ø 5.00 mm	247	4.0513	0.3464	11.50	1.00

The min. and max. flow rate and the pressure loss may vary depending on viscosity.

The values specified must be considered as approximate values.

The number of pulses per litre may differ depending on medium and installation.

We recommend to calibrate the number of pulses per litre in line with the complete installation.

MEASUREMENT TIPS

- Ensure that there is no fast-pulsatory movement of the media
- Ensure that there are no reverse pressure surges
- Ensure that there is no air in the system
- Note the mounting position of the flowmeter
- Min/max flow should be in the linear range of the selected flowmeter
- Clean the system at appropriate intervals
- Avoid electrical current peaks
- Incorrect cabling of power supply +, signal and ground will destroy the flowmeter
- Do not mechanically load electrical contacts
- Avoid moisture on the electrical contacts
- Avoid stray pick-up via the cable (Do not lay cables in parallel with high current loads)

