

DATA SHEET



DIGIMESA

FFG 40 sm 3 Pin Arnite
bearing pin Inox
Part number: 981-2540/X

General Description

The FFG 40 Flowmeter is a general-purpose precision device. It measures with constant precision and guarantees maximum accuracy in the measurement of fluid volumes. Its integrated electronic pulse emitter gives an additional guarantee for a practically unlimited useful life. This flowmeter is employed with great success in beer and premix dispensing systems. In addition to this, it can

measure spirits or chemically-aggressive products and therefore finds much use in the most varied of industrial sectors just as accurately.

Special features: Inlet and outlet are freely selectable. Sturdy bearing. Impulses can be doubled (turbine with 4 magnets). When frothing formation is detected, the built in electronic system interrupts the pulse output.

Approvals / Standards

EN 50081-1:92, EN 50082-1:97,
EN 61000-3-2:00, EN 61000-3-3:95,
IEC 61000-6-3:96, IEC 61000-6-1:96,
IEC 61000-3-2-00, IEC 61000-3-3:94 + A1:01



Material:

| | |
|--------------|--|
| Housing: | PBT 35%GF (Arnite) |
| Bearing pin: | Inox 1.4305 |
| O-ring: | MVQ (Silikon) |
| Turbine: | PVDF 2 Magnets 4 Magnets on request |
| Magnets: | Ceramic Sr Fe O (in contact with the medium) |
| Probes: | Stainless steel 1.4404 with food quality PTFE coating |

Technical data:

| | |
|---------------------|---------------------------------|
| Flow rate: | 0.22 - 7.75 l/min |
| Measuring accuracy: | +/- 2.0% |
| Repetition: | < +/- 0.25% |
| Temperature range: | -10°C to +65°C 14°F to 149°F |
| Pressure range: | 5.5 bar at 20°C 79 psi /68°F |
| Mounting position: | Horizontal recommended |
| Nozzle size: | Ø 4.0mm |

Electrical connection ratings:

| | |
|--------------------|------------------------|
| Power supply: | 10-16 VDC |
| Consumption: | 5 mA to max. 13 mA |
| Signal connection: | Open collector NPN |
| Signal voltage: | 0 V GND |
| Signal load: | max. 20 mA |
| Leakage current: | max. 10 µA |
| Connections: | 3-pin AMP 2.8 x 0.8 mm |
| Signal: | Square-wave output |
| Duty Cycle: | 50% / ±5% |

Dimensions in mm:

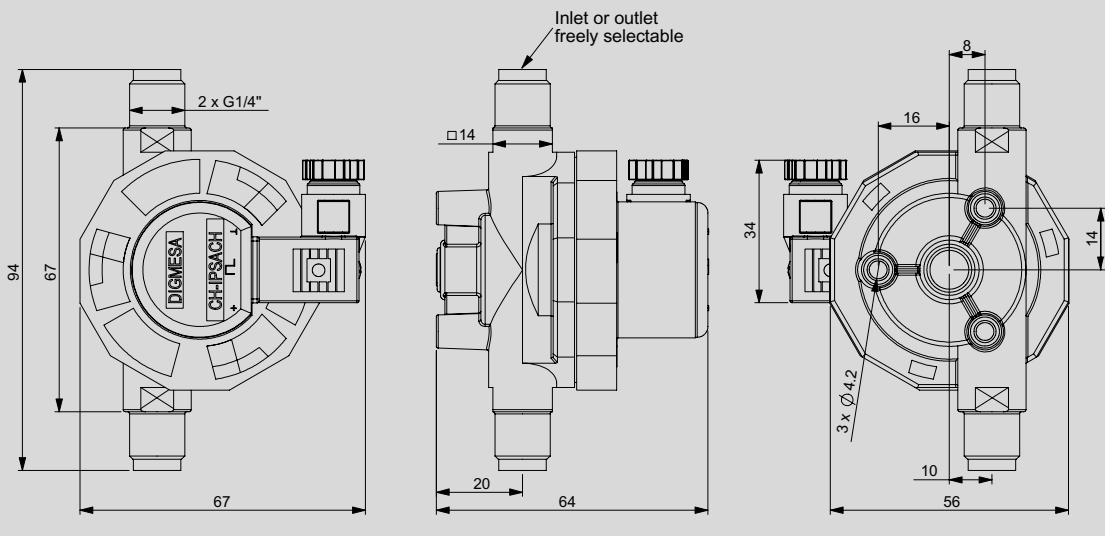

Included in the delivery:

3-pin solenoid socket
Item number: 941-0002/3



We reserve the right to make modifications in the interests of technical progress.

RESISTANCE

Special regulations which must be complied with by the flowmeter manufacturer apply to each country, e.g. CE, NSF, FDA and SK. The various media flowing through the flowmeter differ from application to application. You are advised to enquire with the medium manufacturer as to whether the entire installation and the flowmeter are resistant to the medium itself (see Material)!

ELECTRONIC

DIGMESA electronic circuitry is always designed for operation with DIGMESA flowmeters. Please note the following if connecting to other electronic circuitry:

- The flowmeter does not supply an output voltage but switches the signal terminal to 0 V ground (actuated) or leaves it open (non-actuated)
- There must be a pull-up resistor between power supply + and signal depending on electronic circuitry!

Version 01 FFG 40 sm 3 polig mit Lagerstift 981-2540/X GB Page 2-7

Upper part of FF frothing probe sm 3 or 4 pin

UPPER PART 3 PIN

The frothing probes are in contact with the medium. They recognize whether fluid or froth is present. This information is passed on to the electronic system integrated into the upper part.

When frothing is detected:

- The built-in electronic system interrupts the pulse output
- No further impulses are passed on.

UPPER PART 4 PIN

The frothing probes are in contact with the medium. They recognize whether fluid or froth is present. This information is passed on to the electronic system integrated into the upper part.

When frothing is detected:

- Pulses continue to be passed on.
- The built-in electronic system releases a signal via 4th pin, which needs to be evaluated.

e.g. Block puls input
Switch over keg
Acoustic / optical display

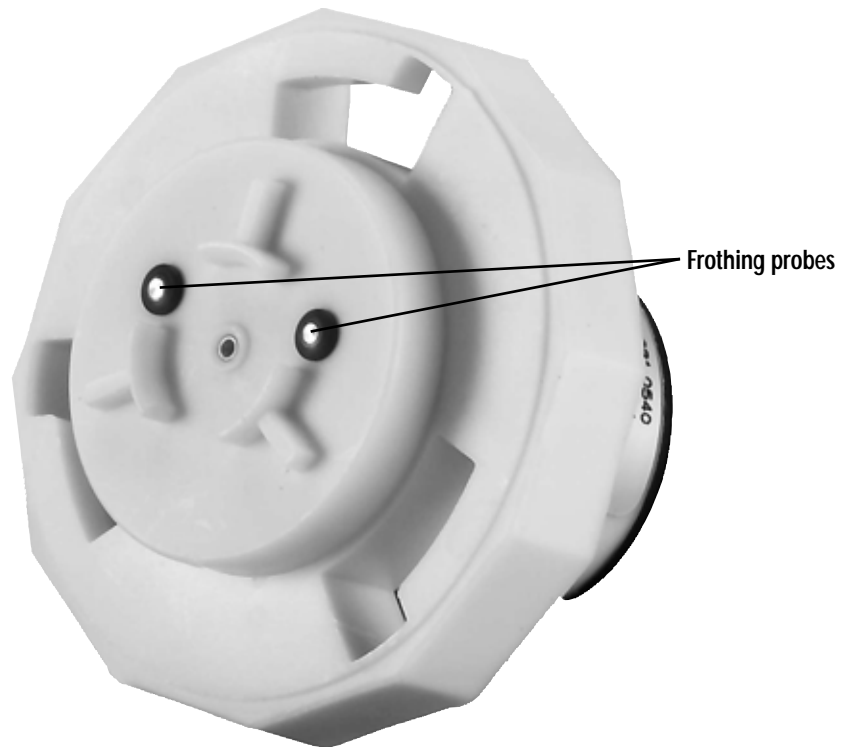

DIGITAL

Interface Connection: Examples sm 3 Pin

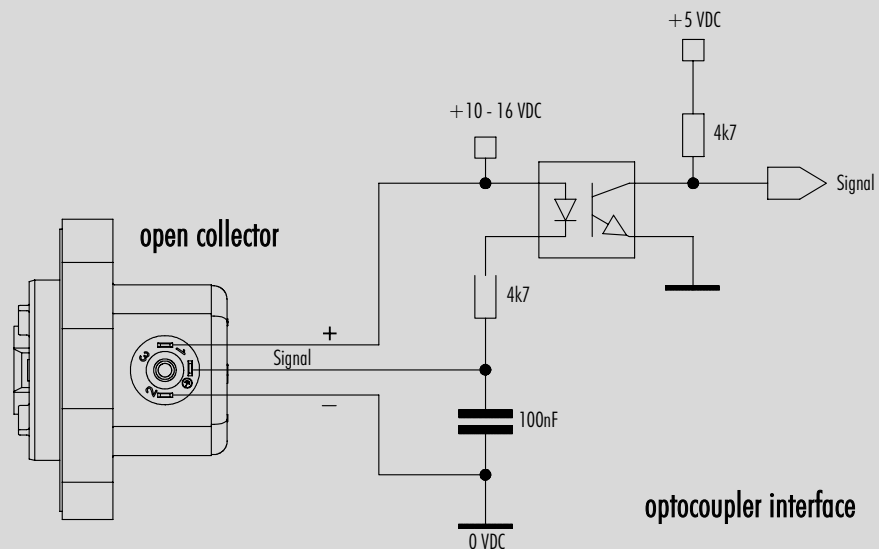
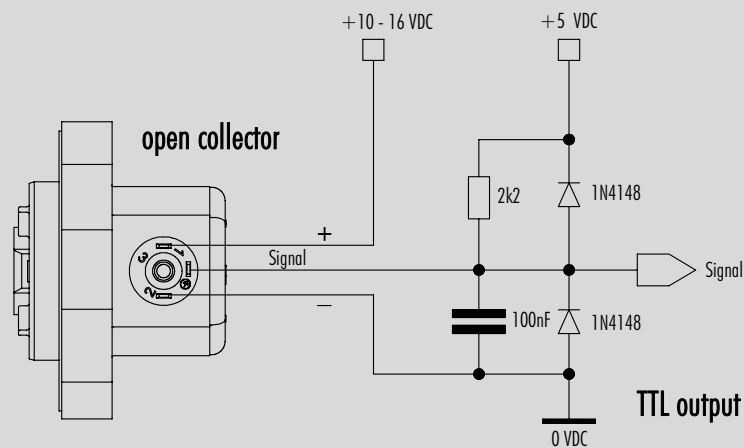
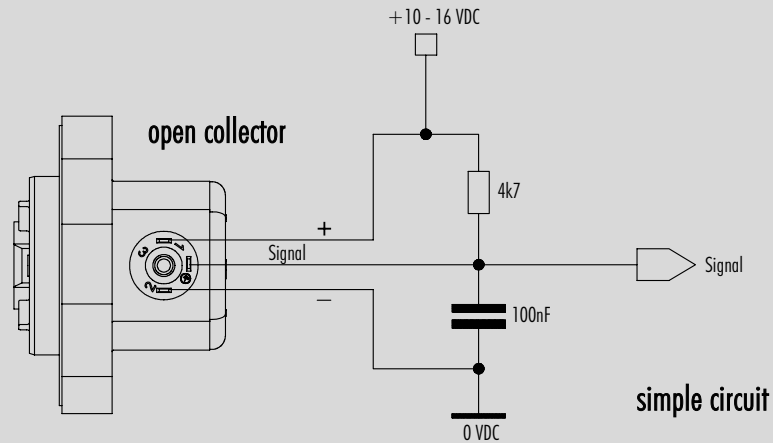

Measurement Curve FF Ø4.00 mm 2 Magnets

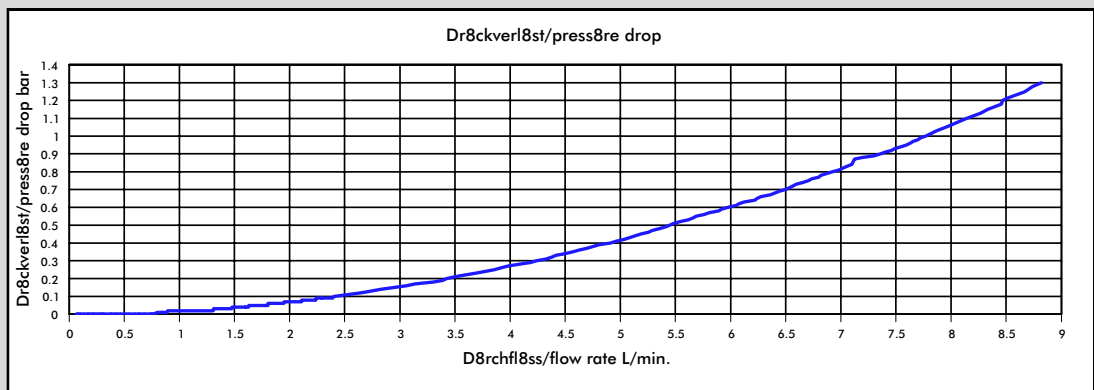

Medium: Water / max. Pressure: 3.3 bar

| Nozzle size | Pulses/litre | g/pulse | min. flow rate in litres/min at Linear start | max. flow rate in litres/min | Pressure loss |
|-------------|--------------|---------|--|------------------------------|---------------|
| Ø 4.00 mm | 343 | 2.9132 | 0.2203 | 7.75 | 1.00 |

The min. and max. flow rate and the pressure loss may vary depending on viscosity.

The values specified must be considered as approximate values.

The number of pulses per litre may differ depending on medium and installation.

We recommend to calibrate the number of pulses per litre in line with the complete installation.

MEASUREMENT TIPS

- Ensure that there is no fast-pulsatory movement of the media
- Ensure that there are no reverse pressure surges
- Ensure that there is no air in the system
- Note the mounting position of the flowmeter
- Min/max flow should be in the linear range of the selected flowmeter
- Clean the system at appropriate intervals
- Avoid electrical current peaks
- Incorrect cabling of power supply +, signal and ground will destroy the flowmeter
- Do not mechanically load electrical contacts
- Avoid moisture on the electrical contacts
- Avoid stray pick-up via the cable (Do not lay cables in parallel with high current loads)

Measurement Curve FF Ø4.00 mm 4 Magnets

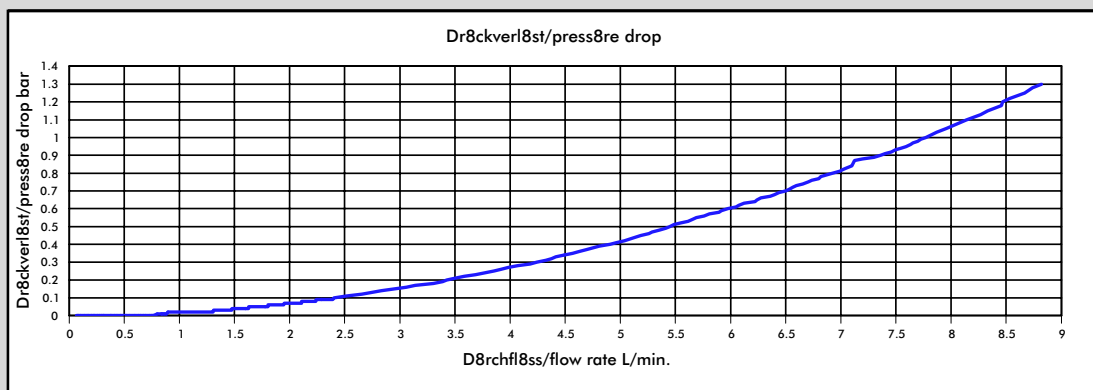
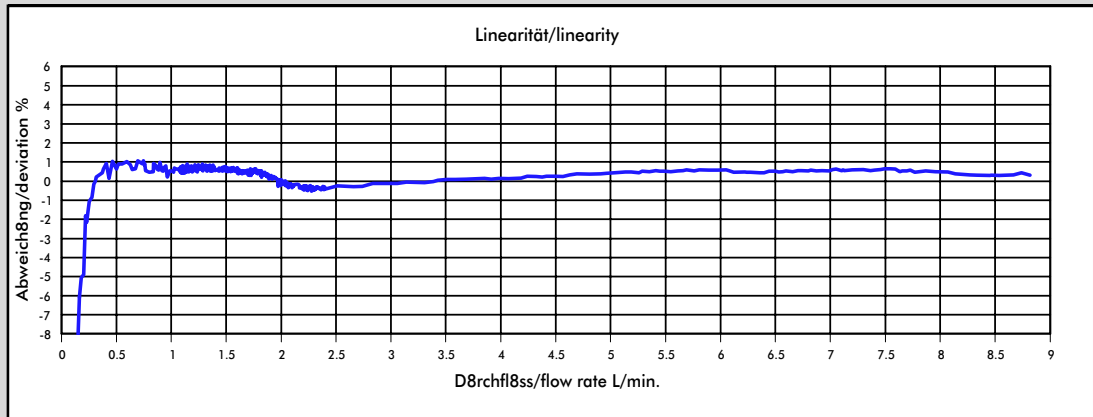

Medium: Water / max. Pressure: 3.3 bar

| Nozzle size | Pulses/litre | g/pulse | min. flow rate in litres/min at Linear start | max. flow rate in litres/min | Pressure loss |
|-------------|--------------|---------|--|------------------------------|---------------|
| Ø 4.00 mm | 686 | 1.4566 | 0.2203 | 7.75 | 1.00 |

The min. and max. flow rate and the pressure loss may vary depending on viscosity.

The values specified must be considered as approximate values.

The number of pulses per litre may differ depending on medium and installation.

We recommend to calibrate the number of pulses per litre in line with the complete installation.

MEASUREMENT TIPS

- Ensure that there is no fast-pulsatory movement of the media
- Ensure that there are no reverse pressure surges
- Ensure that there is no air in the system
- Note the mounting position of the flowmeter
- Min/max flow should be in the linear range of the selected flowmeter
- Clean the system at appropriate intervals
- Avoid electrical current peaks
- Incorrect cabling of power supply +, signal and ground will destroy the flowmeter
- Do not mechanically load electrical contacts
- Avoid moisture on the electrical contacts
- Avoid stray pick-up via the cable (Do not lay cables in parallel with high current loads)

