

DATA SHEET



DiGEMSA

FFG 40 Arnite bearing pin Inox
Part number: 934-2540/X

General Description

The FFG 40 Flowmeter is a general-purpose precision device. It measures with constant precision and guarantees maximum accuracy in the measurement of fluid volumes. Its integrated electronic pulse emitter gives an additional guarantee for a practically unlimited useful life. This flowmeter is employed with great success in beer and premix dispensing systems. In addition to this, it can

measure spirits or chemically-aggressive products and therefore finds much use in the most varied of industrial sectors just as accurately.

Special features: Inlet and outlet are freely selectable. Sturdy bearing. Impulses can be doubled (turbine with 4 magnets).

Approvals / Standards

EN 50081-1:92, EN 50082-1:97,
EN 61000-3-2:00, EN 61000-3-3:95,
IEC 61000-6-3:96, IEC 61000-6-1:96,
IEC 61000-3-2-00, IEC 61000-3-3:94 + A1:01



Material:

Housing: PBT 35%GF (Arnite)
Bearing pin: Inox 1.4305
O-ring: MVQ (Silikon)
Turbine: PVDF 2 Magnets
4 Magnets on request
Magnets: Ceramic Sr Fe O
(in contact with the medium)

Technical data:

Flow rate: 0.22 - 7.75 l/min
Measuring accuracy: +/- 2.0%
Repetition: < +/- 0.25%
Temperature range: -10°C to +65°C
14°F to 149°F
Pressure range: 5.5 bar at 20°C
79 psi / 68°F
Mounting position: Horizontal recommended
Nozzle size: Ø 4.0mm

Electrical connection ratings:

Power supply: 4.5–24 VDC
Consumption: 5 mA to max. 13 mA
Signal connection: Open collector NPN
Signal voltage: 0 V GND
Signal load: max. 20 mA
Leakage current: max. 10 µA
Connections: 3-pin AMP 2.8 x 0.8 mm
Signal: Square-wave output
Duty Cycle: 50% / ±5%

Dimensions in mm:

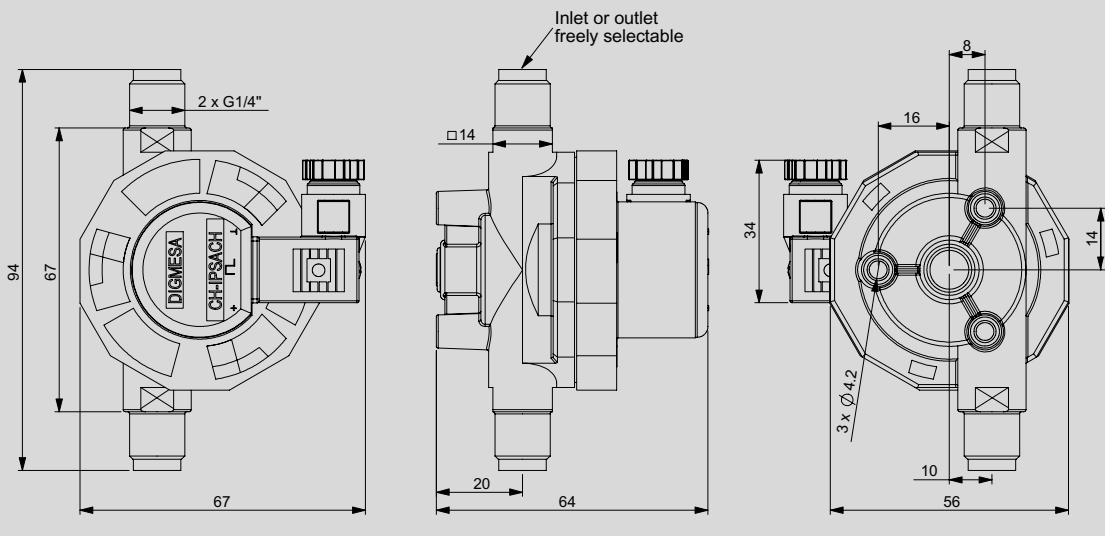

Included in the delivery:

3-pin solenoid socket
Item number: 941-0002/3



We reserve the right to make modifications in the interests of technical progress.

RESISTANCE

Special regulations which must be complied with by the flowmeter manufacturer apply to each country, e.g. CE, NSF, FDA and SK. The various media flowing through the flowmeter differ from application to application. You are advised to enquire with the medium manufacturer as to whether the entire installation and the flowmeter are resistant to the medium itself (see Material)!

ELECTRONIC

DIGMESA electronic circuitry is always designed for operation with DIGMESA flowmeters. Please note the following if connecting to other electronic circuitry:

- The flowmeter does not supply an output voltage but switches the signal terminal to 0 V ground (actuated) or leaves it open (non-actuated)
- There must be a pull-up resistor between power supply + and signal depending on electronic circuitry!

Version 01 FFG 40 mit Lagerstift 934-2540/X GB Page 2-6

Interface Connection: Examples Open Collector

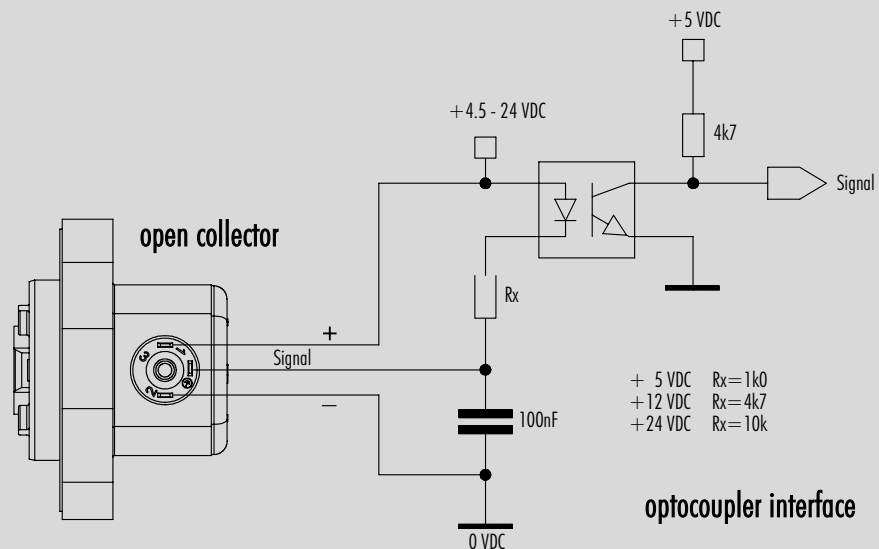
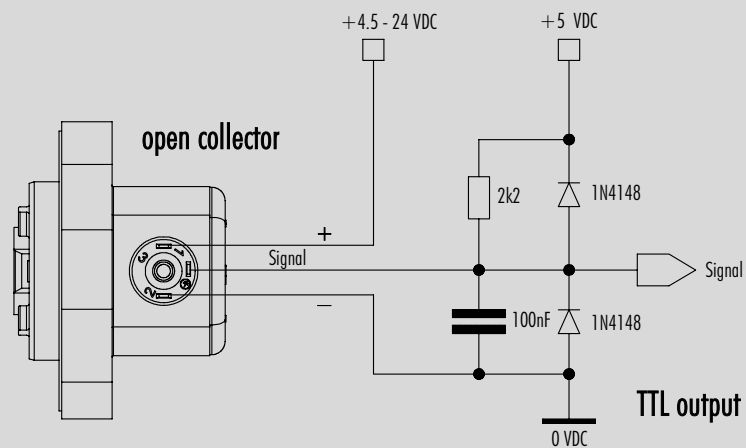
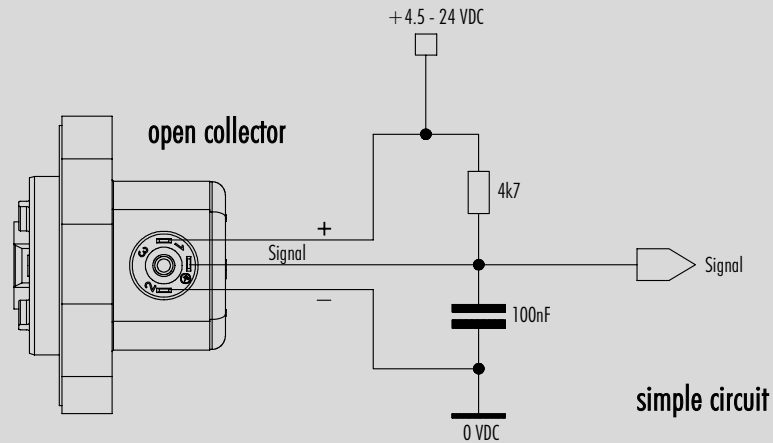

DIGITECH

Measurement Curve FF Ø4.00 mm 2 Magnets

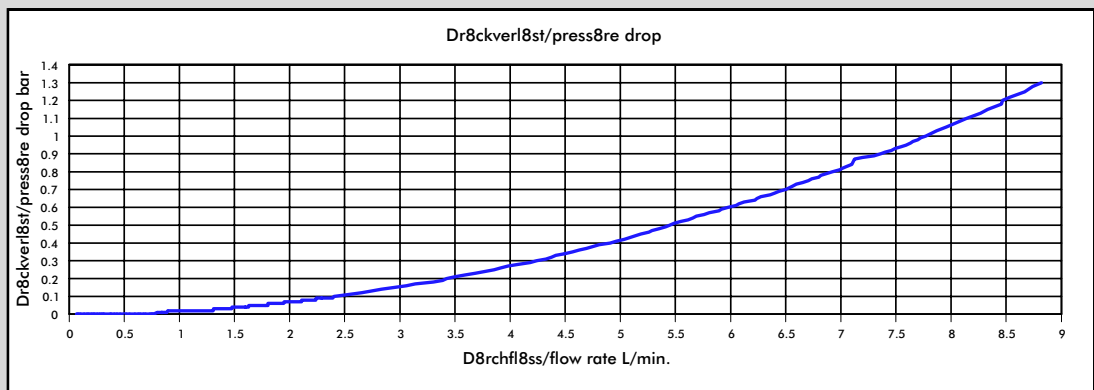
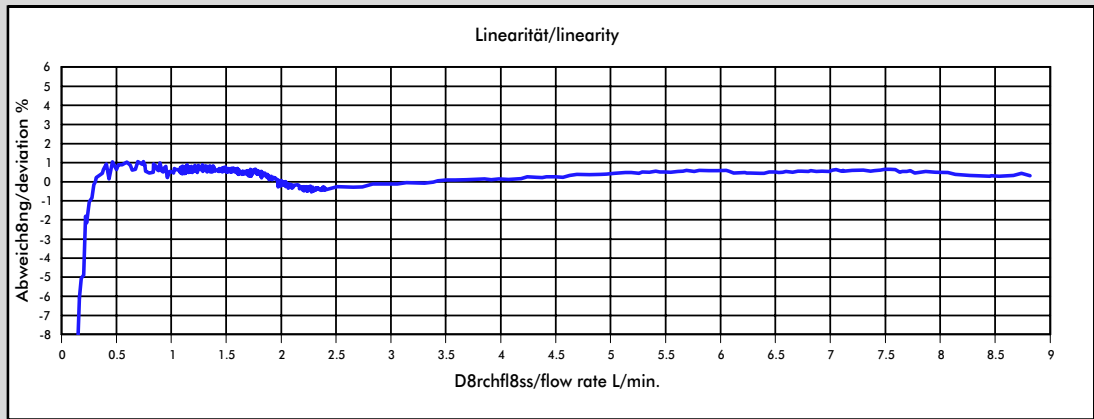

Medium: Water / max. Pressure: 3.3 bar

Nozzle size	Pulses/litre	g/pulse	min. flow rate in litres/min at Linear start	max. flow rate in litres/min	Pressure loss
Ø 4.00 mm	343	2.9132	0.2203	7.75	1.00

The min. and max. flow rate and the pressure loss may vary depending on viscosity.

The values specified must be considered as approximate values.

The number of pulses per litre may differ depending on medium and installation.

We recommend to calibrate the number of pulses per litre in line with the complete installation.

MEASUREMENT TIPS

- Ensure that there is no fast-pulsatory movement of the media
- Ensure that there are no reverse pressure surges
- Ensure that there is no air in the system
- Note the mounting position of the flowmeter
- Min/max flow should be in the linear range of the selected flowmeter
- Clean the system at appropriate intervals
- Avoid electrical current peaks
- Incorrect cabling of power supply +, signal and ground will destroy the flowmeter
- Do not mechanically load electrical contacts
- Avoid moisture on the electrical contacts
- Avoid stray pick-up via the cable (Do not lay cables in parallel with high current loads)

Measurement Curve FF Ø4.00 mm 4 Magnets

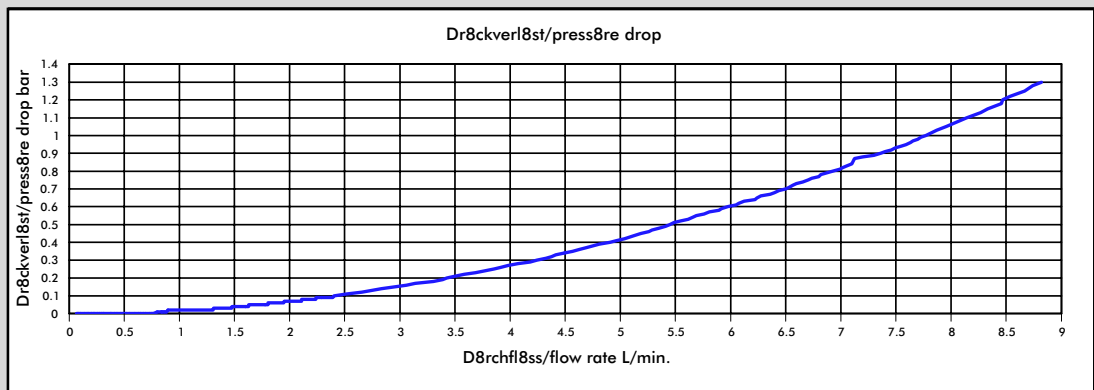
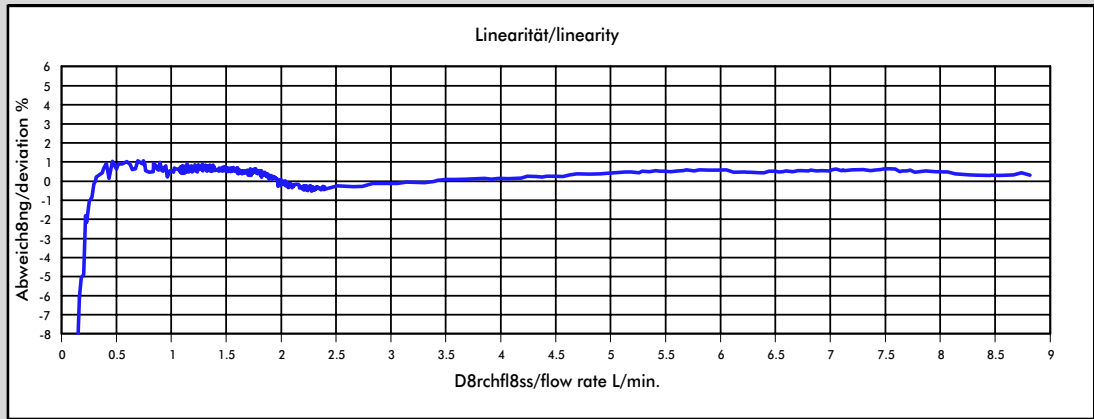

Medium: Water / max. Pressure: 3.3 bar

Nozzle size	Pulses/litre	g/pulse	min. flow rate in litres/min at Linear start	max. flow rate in litres/min	Pressure loss
Ø 4.00 mm	686	1.4566	0.2203	7.75	1.00

The min. and max. flow rate and the pressure loss may vary depending on viscosity.

The values specified must be considered as approximate values.

The number of pulses per litre may differ depending on medium and installation.

We recommend to calibrate the number of pulses per litre in line with the complete installation.

MEASUREMENT TIPS

- Ensure that there is no fast-pulsatory movement of the media
- Ensure that there are no reverse pressure surges
- Ensure that there is no air in the system
- Note the mounting position of the flowmeter
- Min/max flow should be in the linear range of the selected flowmeter
- Clean the system at appropriate intervals
- Avoid electrical current peaks
- Incorrect cabling of power supply +, signal and ground will destroy the flowmeter
- Do not mechanically load electrical contacts
- Avoid moisture on the electrical contacts
- Avoid stray pick-up via the cable (Do not lay cables in parallel with high current loads)

